

# Installation instructions and Operating Instructions

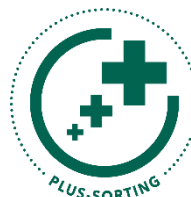

Hergestellt mit  
Ökostrom



## **Installation instructions and Operating Instructions**

These instructions are aimed at dealers, installers and operators of PV systems with polycrystalline or monocrystalline high-performance solar modules produced by Heckert Solar GmbH. They should guarantee that the installed PV system achieves optimum yields for the entire running time. Their disregarding can lead to the loss of the warranty. Please hence, peruse these instructions carefully.

Heckert Solar brand modules must only be mounted by qualified specialist professional companies. Please follow the standards and instructions relevant for the installation and the operation of photovoltaic systems, such as for example the VDE regulations, DIN-standards, VDEW directive, the TAB of the responsible network operators as well as the rules of the trade associations for accident prevention, in particular also IEC 62446 for commissioning and maintenance. Disregard can lead to considerable personal injury and damage to property. The standards and laws applying in Germany form the basis for our information in these installation instructions and operating instructions.

The installation instructions should be a component of the system documentation and be available to the plant operator at any time.

Heckert Solar reserves the right to change this document at any time without advance notice. Please use the most recent version in each case. You can find these on our website at

<http://www.heckertsolar.com/de/downloads/partner-download-center/montage.html>.

These installation and operating instructions are in accordance with IEC 61730-1: 2016.

### Overview

1. Hazard & safety instructions
2. General information about PV systems
3. Delivery & handling of the modules
4. Notes on the module
5. Module assembly
6. Joining and connecting the modules
7. Return & recycling
8. Product and performance guarantee
9. Disclaimer of liability

### 1. Hazard & safety instructions

Solar modules generate electricity as soon as they are exposed to light. A voltage of 30 volts and above represents danger if touched. Every series connection or parallel connection of modules increases the voltage or electricity. Series connections of more than two solar modules can already cause life-threatening voltage!



### **Risk of death by electrocution!**

Though touch protection is given by the fully insulated plug contacts, still pay attention to the fact that, when handling solar modules

- no electrically conductive parts are inserted into the male and female connectors!
- Solar modules and cables are not mounted with wet male and female plugs!
- all works on the circuits are carried out with extreme care!
- high contact voltages can occur in the inverter even when in a disconnected state!
- care must always be taken when working on the inverter and on cables!

Heckert Solar brand modules correspond to class II.



## Risk of death by electric arc!

When opening a closed strand (e.g., during separation of the DC power line from the inverter under load), a deadly electric arc can originate:

- Never separate the solar generator from the inverter, as long as this is connected with the network!

### Work on the roof

Observe the valid accident prevention regulations. Do not carry out the installation work in strong winds. Protect yourself and other people from falling off. Prevent possible falling down of objects. Secure the work area, so that no other people can be injured.

## 2. General information about PV systems

### Alignment

The solar module achieves the highest yield when facing south (in the southern hemisphere to the north). The optimum angle of inclination outside the turning circle can be estimated according to the following formula:

$$\text{Inclination angle} = \text{latitude of the installation site} - 20^\circ.$$

Deviations from the optimum alignment and inclination of the modules lead to decrease in production.

### Location

The area intended for the installation should be as free as possible from shadows of any kind (houses, trees, chimneys, dormer windows, aerials, satellite dishes, cables etc.), because the performance capacity of the solar modules is thereby significantly reduced. Also partial shading leads to considerable yield losses. A module is considered free of shading if it is not completely shaded all year round and an unobstructed light incidence is possible also on the calendrically unfavourable days with low sun position over several hours.

### Back ventilation

The performance of solar modules clearly decreases with warming. This is valid particularly for modules of our Black Edition with black backsheet and black frame. A back ventilation avoids a performance-diminishing heat accumulation. The so-called chimney effect (draught behind the modules) should not be obstructed if possible (e.g., skylight, collectors).

### Winter

The solar system should be mounted in such a way that, if possible, no snow can remain on the modules. Particularly with cases of a low distance to the eaves and a roof inclination  $<20^\circ$ , snow collects on the lower module row. Please note that the bore holes located in the frame and in the corners must remain free to ensure the drainage of condensation water.

### Cleaning / maintenance

With a sufficient inclination of the modules ( $>15^\circ$ ), a cleaning of the modules is generally not necessary (self-cleaning through rain /snow). Nevertheless, the soiling of the modules is strongly dependent on the ambient conditions and should be checked yearly. In cases of strong soiling, we recommend the cleaning of the cooled down modules (e.g., during the morning hours) with a lot of lukewarm, demineralised water and a gentle cleaning tool because sharp edged objects can lead to scratches on the surface or destruction of the anti-reflective (AR) coating. For modules with AR glass, clean, lint-free cotton, microfiber or paper towels should be used. Greasy or oily residues can be removed with alcohol or alcohol/water mixtures. Strong acids, lyes, cleaners on petrol basis, steam as well as hot cleaners should also be dispensed with, as well as cleaners with silicone oils, fluorides or waxes, polishes, alkaline cleaners and cleaners with abrasives and high pressure cleaners. Any methods, means and conditions which can exchange Na ions from the glass surface are not suitable for glass cleaning. Also unsuitable are all abrasive cleaners and utensils. Please note that high variations in temperature can lead to stress in the glass which can destroy the module.



**Please absolutely respect the fact that the gronding must not be interrupted or destroyed during cleaning and maintenance works!**

### 3. Delivery & handling of the modules

The product is to be checked for completeness and intactness immediately upon delivery. Only damage noted on the shipping note of the driver and of which Heckert Solar is informed immediately in writing can be recognised as damage in transit.

Generally, our brand modules are packaged in each case standing upright on a disposable pallet of 27 or max. 18 modules. Be careful when unpacking, transporting and interim storing. We recommend to leave the modules in the packaging until the time of their use. Always place the pallets on horizontal and fixed ground and do not stack them.



**The packaging is not wrapped in foil and thus not rain resistant!**



**Please absolutely pay attention to the removal instructions on the packaging! Never undo the rear retaining strap on pallets with 27 modules!**

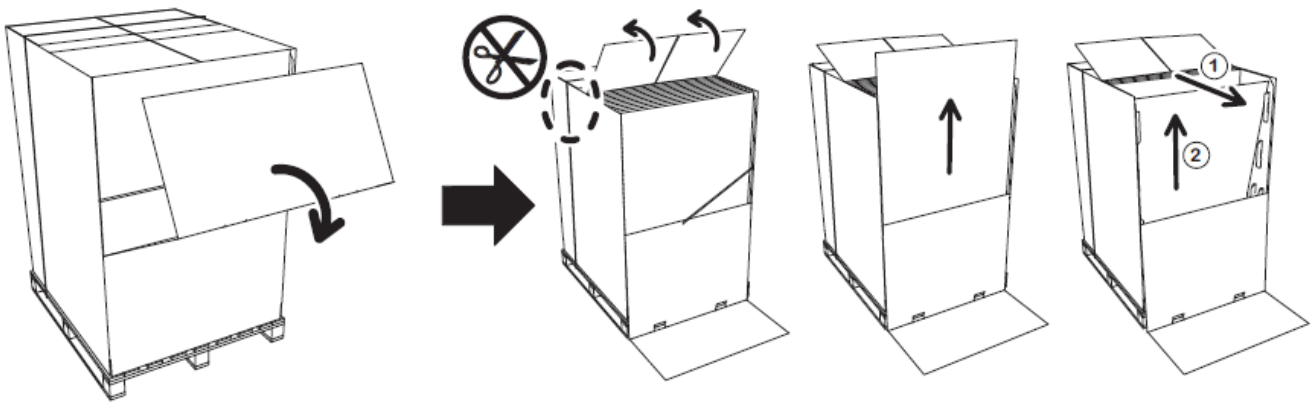

Figure 1: Pallet with 27 modules

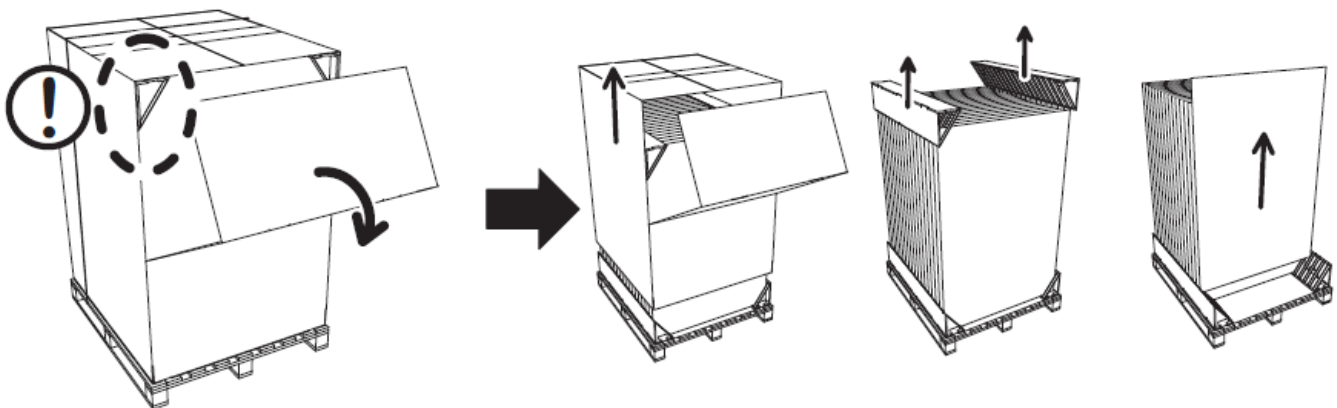

Figure 2: Pallet with 18 modules or less



**Take care when handling the modules!**



- Carry the modules with both hands. Do not use the junction box or the cable (s) as a handle. Please ensure that neither pressure or tension is applied to junction box and cable when transporting and.
- Do not expose the modules to strong vibrations! Do not place the modules roughly on hard ground. Do not place the modules down on their edges. Do not place the modules above each other unprotected. Do not place any objects on the modules. **Never enter the modules!** Do not drop the modules and do not treat them with hard and sharp objects.
- The connecting of the modules has to occur with care and without excessive force according to the instructions. Keep all electrical contacts clean and dry.
- For the possible temporary storage, a dry, ventilated room should be provided.
- For plant documentation, it is recommended to note down the serial number at the installation location in the plant layout plan.
- Do not mount modules with damage.



**Please note the special instructions for use with solar modules with AR glass.**

The surface of AR glass has comparable resistance to mechanical or chemical influence in relation to non-coated glass and should be treated with equal care. Nevertheless, on account of the special reflecting properties, light soiling is better visible than on non-coated glass. In particular, fats/oils are already visible in small quantities and can influence the transmission. To avoid these marks, the modules should only be touched with clean gloves.

#### 4. Notes on the module

##### **Certifications, performance data**

Please, refer to the data sheets of the respective series for performance data as well as information on the certificates of our brand modules.

##### **Operation**

Please observe the following points in particular for the operation of our brand modules:

- The installation or the operation of the solar modules is allowed up to an altitude of max.2000 m above sea level.
- The function of the modules is tested at an ambient temperature of -40 to +85°C. This range should be kept to.
- The solar module is not seawater-proof (recommended distance to the sea 500 m).
- The module must not be exposed to extraordinary chemical pollution (e.g. emissions from manufacturing operations).
- Do not dip the solar module into liquid.
- Do not use lenses or mirrors for light bundling (danger of overheating).
- Avoid damage to the module by hard metal or diamond objects.
- Protect solar modules from overvoltage, e.g. voltage peaks from battery chargers, generators of alternators, etc., in case of doubt, please ask your dealer.
- If solar modules are to be connected to power accumulators, the safety instructions of the respective manufacturer must be observed.
- Keep children away from solar panels.

In southern regions, a PV module can deliver higher currents and voltages than specified during standardised testing conditions (standard test conditions). To determine the voltage ratings of components, current ratings of conductors and magnitudes of fuses connected to the output of PV modules, the values stated on the module of  $I_{sc}$  and  $U_{os}$  should be multiplied by a factor of 1.25. The highest rating of the overcurrent protection (reverse current resistance) amounts to 20 A.

## 5. Module Assembly

### General information on module assembly

All modules can be arranged horizontally as well as vertically regardless of the junction box.

The modules must be mounted free of voltage. The modules do not serve as a flexurally rigid connecting or fastening element.

### Load on the modules

The load performance of the standard-solar modules is depend on the installation situation and the assembly system used. Therefore, please observe the installation situations displayed in following table and the maximum load performance of the modules resulting from it.

The specified values (Fig. 3) correspond to the rated load according to IEC 61215: 2016. The cyclic load test is carried out according to the standard with the 1.5-fold higher test load.

### Standard situation with continuous mounting rails

Please, note that the module can bend with high loads and lay down on the mounting rails. Pay attention to the fact that the mounting rail has sufficient stability and the fastening points are set accordingly frequently to prevent bending of the mounting rail. (tested with rail Heckert Solar and a support distance of max. 1m)

Resilience pressure **5400 Pa**  
suction **1600 Pa**

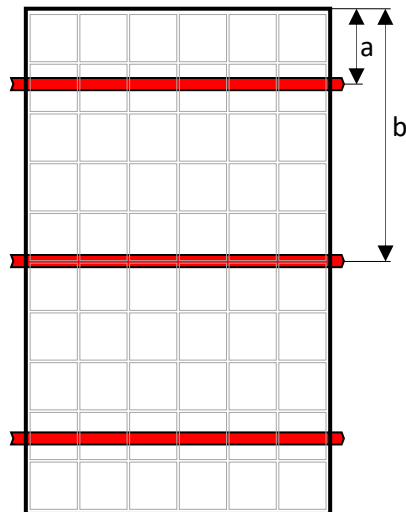

a = 250mm; b = 835mm  
6 fastening points

Resilience pressure **3600 Pa**  
suction **1600 Pa**

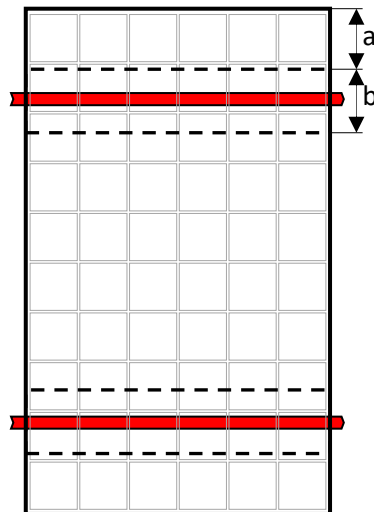

a = 250; b = 160mm  
4 fastening points

Resilience pressure **3600 Pa**  
suction **1600 Pa**

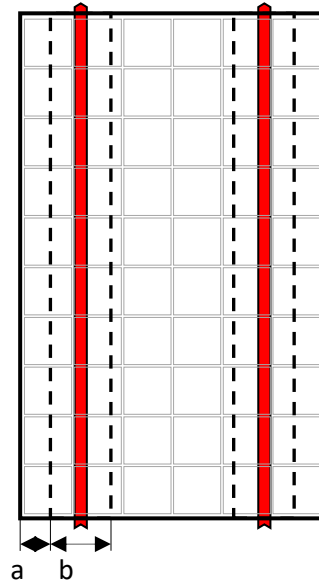

a = 100mm; b = 200mm  
4 fastening points

Standard situation without continuous mounting rails

Resilience pressure **1600 Pa**  
suction **1600 Pa**

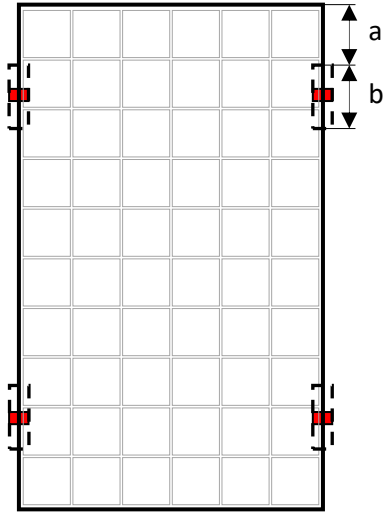

$a = 200\text{mm}$ ;  $b = 210\text{mm}$   
4 fastening points

Resilience pressure **1600 Pa**  
suction **1600 Pa**

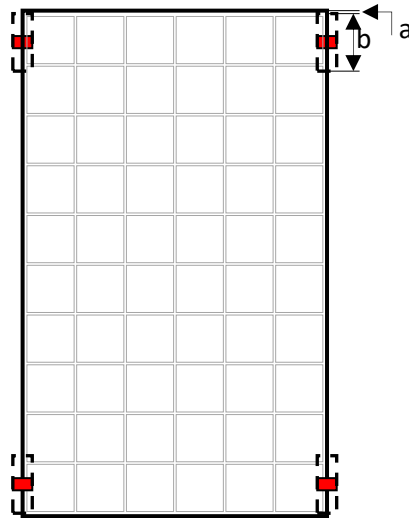

$a = 10\text{mm}$ ;  $b = 200\text{mm}$   
4 fastening points

Resilience pressure **1600 Pa**  
suction **1600 Pa**

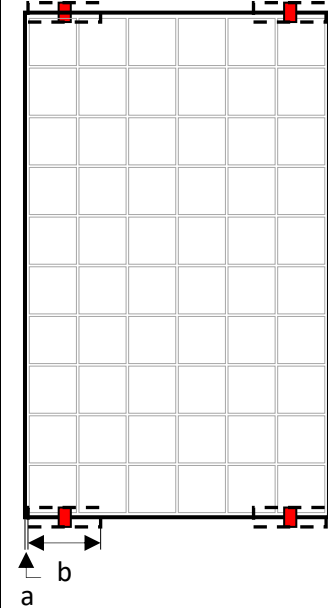

$a = 10\text{mm}$ ;  $b = 200\text{mm}$   
4 fastening points

**Suspended systems**

Resilience pressure **2400 Pa**  
suction **1600 Pa**

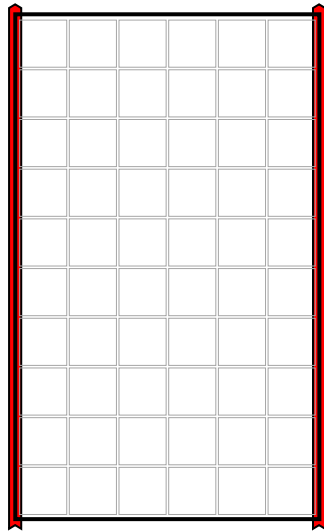

Linear overlay long side

Resilience pressure **3600 Pa**  
suction **1600 Pa**

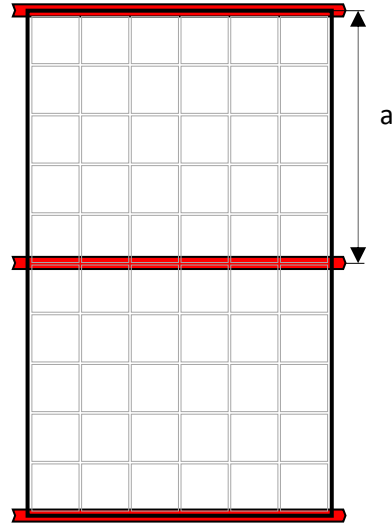

$a = 835\text{mm}$   
Linear overlay short side +  
continuous rail

Resilience pressure **1600 Pa**  
suction **1600 Pa**

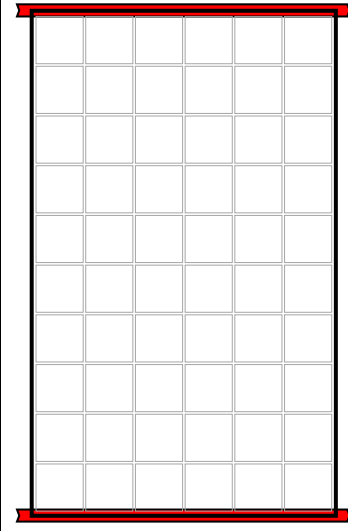

Linear overlay short side

Figure 3: Load capacity depending on the installation situation



**The maximum loading performance of the modules is only achieved with a clamping in the specified range and observance of all specifications!**

Pay attention to the observance of the mechanical maximum permissible load, in particular also taking into account the location-dependent exposure through e.g. wind and snow (DIN 1055-4/5).

Use no fastening material by which the module can be damaged, e.g. material with pointed, sharp-edged or uneven structures. The applied snow load on the ground sk in  $\text{kN/m}^2$  arises from the respective snow load zone, the building location and the terrain elevation above sea level. The applied snow load for the project location is to be determined from the wind zone map which also considers the location situation in addition to wind zones. With buildings up to a height of 25m, the applied wind load can be determined according to a simplified procedure. Depending on building heights, the wind load is stated as a velocity pressure  $q$  in  $\text{kN/m}^2$ .



**Please, note that the sole responsibility for planning and implementation of the project lies with the executing company and it is necessary in some cases to create an object structural stability report!**

### Slip protection

To avoid slipping off the modules during assembly at an inclined level and to facilitate the assembly, our module frames are provided with bore holes for slip protection. In these holes in the module frame, cylinder head screws with hexagon socket are fitted. The securing of the bolts takes place with a flat washer and nut or by means of self-locking nut. For the slip protection, a screw M5x10 VA and the accompanying toothed washer and nut is recommended.

### 6. Joining and connecting the modules

The solar modules of Heckert Solar are basically available in 3 different configurations:

- Plug connector PV4-S (TE connectivity)
- Plug connector MC4 (Stäubli – Multicontact)
- Plug connector Solarlok (TE connectivity)



**Please note that plugs of different manufacturers and types must not be combined. Only varieties pure connections are allowed.**

Especially when using power optimizers or module inverters, the selection is crucial and must be taken into account already during plant design, particularly with regard to the use of connectors that conform to the optimizer.

Please also note that exclusively the right tool must be used for crimping the plug.

Defective crimp connections can lead to considerable damage to the modules up to fire in the system.

The modules are connected into strings in series connection. The voltage of the modules in the string adds up in doing so. Please, note that the allowed system voltage of 1000V must not be exceeded, even at very low temperatures.



**Please note that it is mandatory to avoid tensile forces on the connecting.**



**Connectors in DC circuit of a PV system shall comply with EN 62852. Only connectors from the same manufacturer shall be mated together.**



**Any change to the junction box can lead to loss of warranty and must only be carried out by trained specialist staff.**



**Pay attention to a tensile stress-free laying of the cables and to proper plug and crimp connection!**





## Do not mount modules with damage!

### Modules with connection PV4-S or MC4 (two-cable solution)

With both variations, you will find 2 permanently attached cables at the junction box. The socket (+) is on the left, the plug (-) on the right. (Fig. 4). The shape of the terminals is in each case designed so that no confusion is possible.

The individual solar modules of a string can thus be interconnected. Pay attention to correct engaging of the plug connectors.

The string cables are provided with the same connector type (PV4-S or MC4) as the connector used on the module and connected to the first or last module in the string.

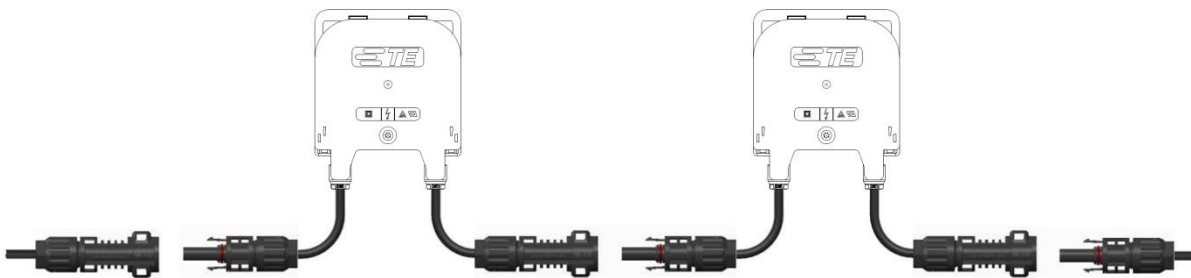

Figure 4: Connecting the modules PV4-S or MC4 (illustration: PV4-S)

It is essential to comply with the requirements laid down in DIN VDE 0298-3 for laying cables, especially the smallest permitted bending radii (Fig. 5;  $R > 5 \times \text{cable } \varnothing$ ) and the standards for cable fastening and laying.

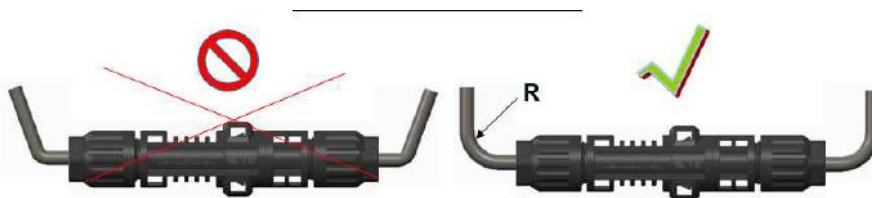

Figure 5: bending radii (illustration: PV4-S)

- The plug connectors have the protection class IP68, the junction box IP67. Both components are thus protected permanently against dust influence.
- Please, absolutely follow the notes and installation instructions of the respective manufacturer. See annex. You will also find the instructions of TEconnectivity and Multicontact on our homepage (<https://www.heckertsolar.com/de/downloads/partner-download-center/montage.html>).

	<b>TE hand crimping tool PV4 4mm<sup>2</sup> + 6mm<sup>2</sup></b>	Hand crimping tool PV4 (6-1579014-8, complete), 4mm <sup>2</sup> and 6mm <sup>2</sup>	<b>40214000000033</b>
	<b>TE crimping head PV4 4mm<sup>2</sup> + 6mm<sup>2</sup> for TE hand crimpers</b>	Crimping head / attachment for use with TE pliers (PN 4-1579016-7)	<b>40214000000034</b>
	<b>TE plug connector - socket PV4-S 4-6mm<sup>2</sup></b>	TE - 2270025-1, socket, PIN for 4 and 6mm <sup>2</sup> (plus)	<b>40214000000035</b>
	<b>TE plug connector - plug PV4-S 4-6mm<sup>2</sup></b>	TE - 2270024-1, plug, PIN for 4 and 6mm <sup>2</sup> (minus)	<b>40214000000036</b>
	<b>MC4- plug PV-KST4/6II-UR</b>	plug 4-6mm <sup>2</sup> ; for cables- Ø 5,5-9,0mm (minus)	<b>40201000000000</b>
	<b>MC4-socket PV-KBT4/6II-UR</b>	socket 4-6mm <sup>2</sup> ; for cables-Ø 5,5-9,0mm (plus)	<b>40211000000000</b>
	<b>MC4 crimping tool</b>	Hand crimping tool PV4 (6-1579014-8, complete)	<b>40215000000001</b>

Figure 6: Accessories PV4-S and MC4

### Module with TE connectivity - Solarlok (single cable solution, plugged in)

- The modules are connected via the plug connectors located directly on the junction box (Fig. 8): Left male connector (+); Right pin connector (-) and the supplied module cable. Make sure that the connector engages (audible "click").
- When delivered, a cable is attached to the plus side (left). This cable is provided with an original female connector in each case (+) or (-). The shape of the terminals in the interior is in each case designed so that no confusion is possible.
- For the connection on the junction box, exclusively the corresponding female connectors of TE connectivity are authorized (Fig. 7). The use of other plug connectors leads to loss of warranty claims.



	<b>TE plug connector plus 4mm<sup>2</sup> socket</b>	plus 4mm <sup>2</sup> female connector	0-1394462-3 (Art. TE) Outer Ø 5,5-8,0	<b>40214000000024</b>
	<b>TE plug connector plus 6mm<sup>2</sup> socket</b>	plus 6mm <sup>2</sup> female connector	4-1394462-8 (Art. TE) Outer Ø 5,5-8,0	<b>40214000000001</b>
	<b>TE plug connector minus 4mm<sup>2</sup> socket</b>	minus 4mm <sup>2</sup> female connector	5-1394462-5 (Art. TE)	<b>40214000000005</b>
	<b>TE plug connector minus 4mm<sup>2</sup> socket</b>	minus 4mm <sup>2</sup> female connector	1394461-4 (Art. TE) Outer Ø 5,5-8,0	<b>40214000000026</b>
	<b>TE plug connector minus 6mm<sup>2</sup> socket</b>	minus 6mm <sup>2</sup> female connector	4-1394462-9 (Art. TE) Outer Ø 5,5-8,0	<b>40214000000003</b>
			5-1394462-6 (Art. TE)	<b>40214000000007</b>

Figure 7: Accessories Solarlok

- The crimping of the plug connectors can only occur with the original tools from TE connectivity. Defective crimp connections can lead to considerable damage to the modules up to fire in the system.
- The TE plug connectors must only be connected directly to the junction box. A flying coupling (plug connection between two cables) is not certified. Hence, the string cables must therefore be assembled with the TE socket connectors. Then, the first/last cable in the string is not required.
- Alternatively, the free cable can be divided **in the middle**. At the free ends, you can then continue to work with any certified PV plug connectors. Please, note that connection is only permitted with plug connectors of the same type and manufacturer.



Figure 8: Junction box and cable

- Please, do **not** pull on the connecting cable when plugging in.
- Please, absolutely follow the attached instructions from TE connectivity.

### Cable installation

Each string requires 2 cables that connect the solar generator to the inverter. Please use a solar cable that complies with the EN 50618 Class 5 standard and the respective requirements. The minimum cross section is 4 mm<sup>2</sup>. Cable losses should be <1%. For larger distances, the cable cross-section must be adjusted accordingly. It is essential to comply with the requirements laid down in DIN VDE 0298-3 for laying cables.



**Please pay attention to a correct connection of the plugs and sockets!**

The strings (+ and - cables) are routed to the inverter and connected to the DC inputs. The modular plugs are marked. To avoid conductor loops, the strings (+ and -) should be installed together.

When connecting the strings to the inverter, pay attention to the polarity. The + and - cables must not be interchanged. With a multimeter/voltmeter, the individual strings should be checked for polarity and voltage before connecting to the inverter.

For the connection of the solar cables to the inverter only certified and suitable plug connections are permitted. The installation or connection of the inverter(s) must be carried out in accordance with the manufacturer's instructions.

The instructions of the inverter manufacturer are binding.



**Depending on the module power and inverter type, different string lengths are possible. Make absolutely sure that the permissible system voltage cannot be achieved, even in no-load conditions (V<sub>oc</sub>) and at low temperatures.**

### Parallel connection of PV modules

When connecting our brand modules, it must be kept in mind that string fuses (safety fuse 16 A) must be used for the parallel connection of more than 2 strings.

The maximum reverse current load-bearing capacity amounts to 20 A. If more than two strings are connected in parallel, this can be exceeded in the event of a fault.

## Electrical installation

The connection of the inverter to the public power supply must always be carried out by a licensed specialist company.



**Even low exposure already produces high DC voltage. Never touch bare + and - wires in operation!**

## Equipotential bonding

The requirements of the lightning arrester and surge protection are dependent on local circumstances. If an external lightning arrester system already exists or is planned on the building, the PV system must be integrated into the protection concept against direct lightning strike.

When using transformer-less inverters, equipotential bonding may be mandatory because of the lack of galvanic isolation for personal safety reasons. The country-specific laws apply.

Proper equipotential bonding of the module frames is the responsibility of the installing company. Country-specific standards must be adhered to.

On the short sides of the module frame, a hole for equipotential bonding is located in the center and marked with the corresponding symbol (Fig. 9).

For equipotential bonding, a screw M4 is required. The attachment must be made with spring washer or toothed disc to ensure that the anodized layer is penetrated.



Figure 9: Equipotential bonding symbol and design

## Fire protection

The erection of rooftop systems can influence the fire safety of a building; Improper installation can lead to a hazard in case of fire. Please note the building law requirements of the LBO. In the case of roof-mounted systems, the Heckert Solar brand modules must be installed above a fire-resistant substrate. The module is a "non-explosion-proof equipment". Therefore, it must not be installed near flammable gases and vapours (such as gas stations, gas tanks, paint spraying equipment). The modules must not be installed next to open flames and flammable materials.

The modules from Heckert Solar were tested for their fire behaviour according to IEC 61730-1: 2004 and ISO 11525-2: 2014. Our modules are considered to be normally flammable. Heckert Solar assumes no warranty if the substrate, in particular the roofing, is not suitable.

A clear identification of the PV system as well as a system plan at the house junction box and the building main distribution are recommended.

## 7. Return & Recycling

Return and recycling of solar modules are regulated in the WEEE directive ElektroG2. Please observe country-specific regulations. Possibly, a notification may be required in the respective country.

EAR registration number DE42676826

## 8. Product and performance guarantee

Information and conditions for our product and performance guarantees can be found on our homepage [www.heckert-solar.com](http://www.heckert-solar.com).

## 9. Disclaimer of liability

These installation and operating instructions apply to commonplace systems. All information without guarantee. Heckert Solar GmbH reserves itself the right to revoke the warranty for the suitability and functionality of the modules if you deviate from the instructions contained in this user information. Since neither the observance of this user information nor the conditions, the use and the methods of installation, nor the plant operation, nor the maintenance of the modules can be controlled or monitored by Heckert Solar GmbH, Heckert Solar GmbH accepts no liability for damages that occur due to improper use, faulty installation, operation, use or maintenance.

In addition, the liability for patent infringement or infringement of other rights of third parties arising out of the use of the modules is excluded unless otherwise required by law.

Our application engineering department will be happy to answer further questions under phone no. +49(0)371/458568-0.

Annex: Assembly Instructions TE connectivity, Warranty Terms Heckert Solar GmbH

Heckert Solar GmbH • Carl-von-Bach-Straße 11 • D-09116 Chemnitz

## SOLARLOK installation instructions for PV junction boxes with integrated connector system

### 1. Safety Note

- The SOLARLOK connector is to be used only to interconnect firmly fixed cables.



**Do not disconnect under electrical load!**

- Electrical current path should only be disconnected using approved devices.
- Only cables released from TE Connectivity (TE) are permitted to be used with SOLARLOK component cable assemblies.
- SOLARLOK component cable shall be labelled with label PN 1718077-1 "Do not disconnect under load".

- To protect against shock, ensure that conductors and their associated connectors are separated from opposite polarity components.
- Unconnected connectors **must** always be protected from pollution (e.g. dust, humidity, foreign particles, etc.), prior to installation. Do not leave unconnected (unprotected) connectors exposed to the environment. The usage of TE connector dust caps is strongly recommended.
- Connectors that are unmated in the field should also be protected from pollutants.



Do **NOT** use any **oil or lubricants** during mounting.

### 2. Tools

Installer Starter Kit	(1)	Crimping Tool +++	PN 5-1579010-4
Stripping Tool	(2)	2.5 mm <sup>2</sup> - 6.0 mm <sup>2</sup>	PN 4-1579002-2
Crimping Tool	(3)	4.0 mm <sup>2</sup> and 6.0 mm <sup>2</sup>	PN 1-1579004-2
Extraction Tool	(4)	all terminals	PN 1102855-3
Field Service Kit	(5)	all in one	PN 1534858-1

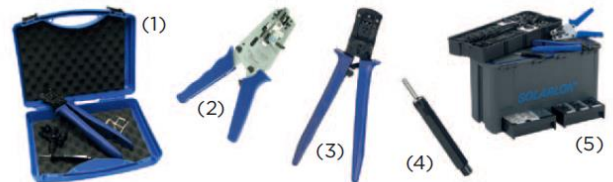

### 3. Assembly Steps

- 3.1** Using the appropriate wire stripping tool, strip the wire **9 mm ± 1 mm** without damaging the strands.



- 3.2** Insert the stripped wire into the terminal wire crimp barrel until it stops. While holding the wire in place, squeeze the crimp tool handles together until the ratchet releases.



### Pre-Assembled (Connector Kit)

- 3.3** Push contact with cable into the connector housing until you hear the contact give an audible click and you feel the contact reach the end position. To verify contact engagement, give a slight gentle pull back on the cable, to be sure that the contact is locked.



- 3.6** Tighten the cable screw lock. The initial assembly tightening torque is **1.3 + 0.2 Nm**. For this, a slotted socket wrench with wrench size 13 mm, is recommended **PN 523229-1**.



---

Connection example for the series connection of PV modules with cable cross section  
**4.0 mm<sup>2</sup>** and an outside diameter  $\varnothing$  of the PV line of **4.5 - 6.9 mm**

#### 4. Connector Mating

The **connector system** is **fully latched only**  
**when the latches have clicked onto**  
**the mating connector.**

#### 5. Wiring

Radius (r)  
min. 5x cable  $\varnothing$   
also applies to  
connection box



#### 6. Connector Unmating

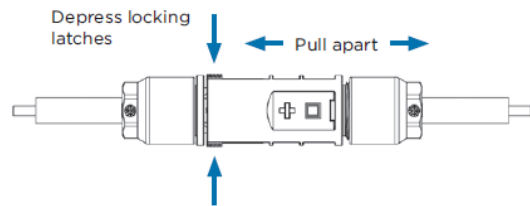

## Excerpt Crimping instructions PV4-S (source TE connectivity)

### Note:

Solarlok PV4 contacts will be applied in compliance to application specification 114-106078. According to this, following crimp heights and stripping lengths have to be complied for the specified wire sizes :

Wire Size mm <sup>2</sup> / AWG	Crimp Height mm	Stripp Length mm
4,0 / 12	2,14 ± 0,05	6,5 + 1,0 - 0,05
6,0 / 10	2,49 ± 0,05	6,5 + 1,0 - 0,05

Crimping Solarlok PV4 contacts proceed as follows:

- 1.** Strip the wire insulation to the specified length from the table above, taking care not to bend or to damage the wire strands.
- 2.** Hold the crimp hand tool so that the crimping cavities of crimp head are facing you. Squeeze the hand tool handles together and allow them to open fully.
- 3.** Choose the according crimp cavity for the wire size you apply. Crimp wire sizes are marked on the crimp head.
- 4.** Push the contact holder of contact locator and slide the contact in the crimp cavity, taking care to slide the contact up to stop in the contact locator (see figure 6).



Figure 8

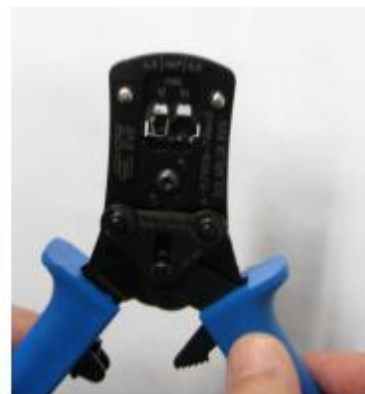

Figure 9

5. Loosen the contact holder which clamps the contact in the contact locator (see figure 7).
6. Hold the contact in position but do not squeeze the tool handles together. Make sure you do not deform the crimp sleeve of the contact. (see figure 7).
7. Insert the stripped wire into the contact crimp sleeve up to stop (see figure 8).



Figure 8



Figure 9

8. Hold the wire in place against stop and squeeze the tool handles together until the ratchet releases. Allow the tool handles to open fully, push the contact holder and remove the crimped contact (see figure 9).



Figure 10

9. Check the crimp height of the crimped contact. For this exclusively refer to the data in the application specification 114-106078 from TE Connectivity.

## Excerpt Crimping instructions MC4 (source Multi-Contact)



### Tools required

#### (ill. 1)

Stripping pliers **PV-AZM...** incl. built-in blade as well as hexagonal screwdriver A/F 2,5.

Cable cross section: 1,5 / 2,5 / 4 / 6mm<sup>2</sup>

Type: PV-AZM-1.5/6

Order No. **32.6029-156**

Cable cross section: 4 / 6 / 10 mm<sup>2</sup>

Type: PV-AZM-4/10

Order No. **32.6027-410**



#### (ill. 2)

Crimping pliers **PV-CZM...** incl. Locator and built-in crimping insert.

Crimping range:  
1.5/2.5/4 mm<sup>2</sup> (14/12 AWG)

Type: **PV-CZM-18100**

Order No. **32.6020-18100**

Crimping range:  
2.5/4/6 mm<sup>2</sup> (12/10 AWG)

Type: **PV-CZM-19100**

Order No. **32.6020-19100**

Crimping range:  
4/10 mm<sup>2</sup> (12 AWG)

Type: **PV-CZM-20100**

Order No. **32.6020-20100**



#### (ill. 3)

Open-end spanner **PV-MS**, 1 Set = 2 pieces

Order No.: **32.6024**



(ill. 4)  
**PV-WZ-AD/GWD** socket wrench  
 insert to tighten  
 Order No. **32.6006**



(ill. 5)  
**PV-SSE-AD4** socket wrench insert to  
 secure  
 Order No. **32.6026**



(ill. 6)  
 Open-end spanner **PV-PST**  
 Order No. **32.6028**

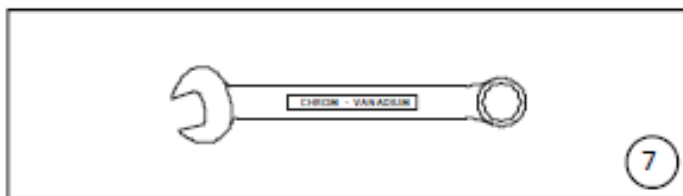

(ill. 7)  
 Open-end spanner A/F 15 mm



(ill. 8)  
 Torque screwdriver A/F 12 mm

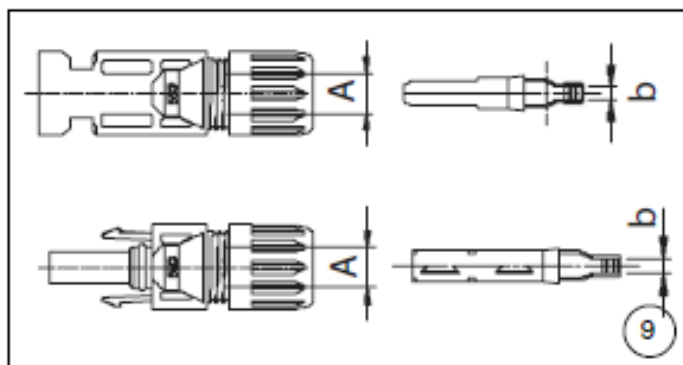

### Cable preparation

Cables with a strand construction of classes 5 and 6 can be connected.

#### ⚠ Attention:

Use no uncoated or already oxidised conductors. It is recommended to use tinned conductors. All MC solar cables have high-quality, tinned conductors.

#### (ill. 9, Tab. 1)

Check dimensions A and b in accordance with illustration 9 and table 1.

Tab. 1

b: Control dimension	Conductor cross section		A: Ø range of cable mm	
			3,0 - 6,0	5,5 - 9,0
mm	mm <sup>2</sup>	AWG	Type	
~ 3	1,5 - 2,5	14	PV-K...T4/...2,5I	PV-K...T4/...2,5II
~ 5	4 - 6	12 / 10	PV-K...T4/...6I	PV-K...T4/...6II
~ 7,2	10	-		PV-K...T4/...10II

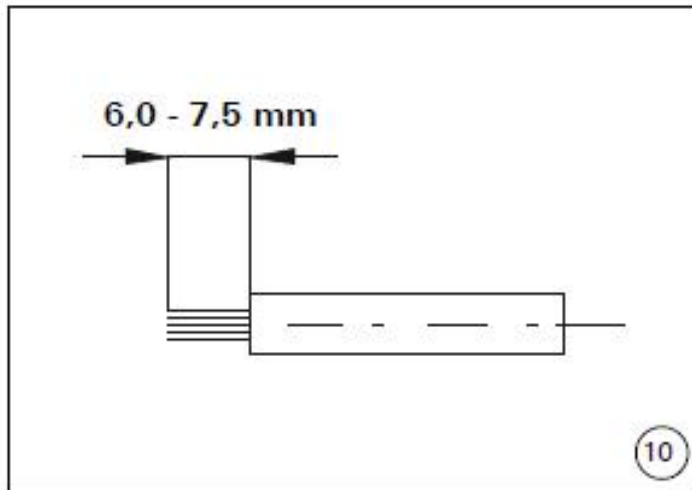

**(ill. 10)**

Strip cable insulation.

Remove 6.0 to 7.5 mm of insulation from the end of the cable.

**⚠ Attention:**

Do not cut individual strands at stripping

**i Note:**

For directions on the operation of stripping pliers PV-AZM... and changing blade sets, see operating instruction MA267 at [www.multi-contact.com](http://www.multi-contact.com)

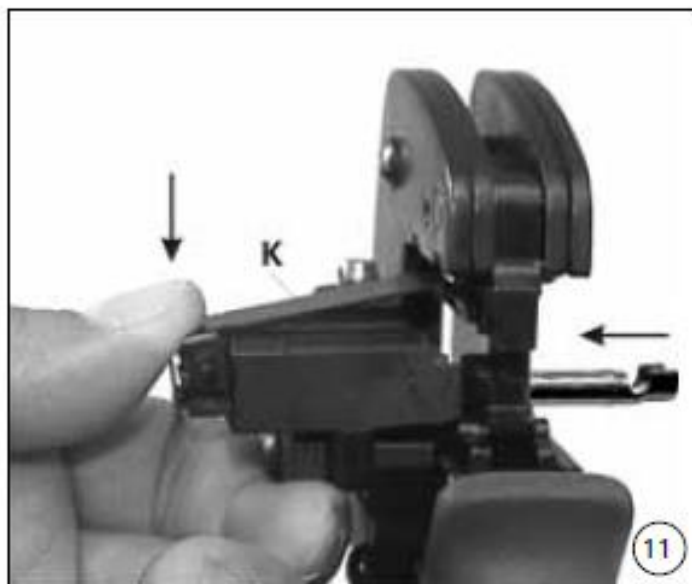

**Crimping**

**(ill. 11)**

Open the clamp (K) and hold. Place the contact in the appropriate cross-section range.

Turn the crimp lugs upwards. Release the clamp (K). The contact is fixed.



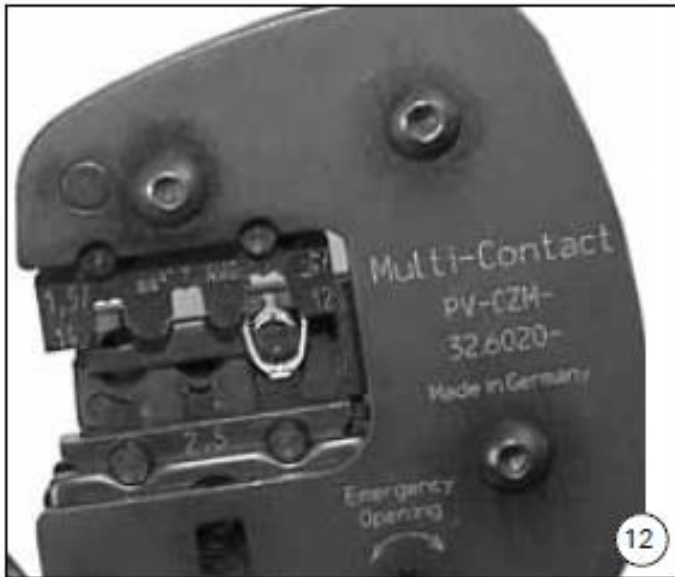

**(ill. 12)**

Press the pliers gently together until the crimp lugs are properly located within the crimping die.

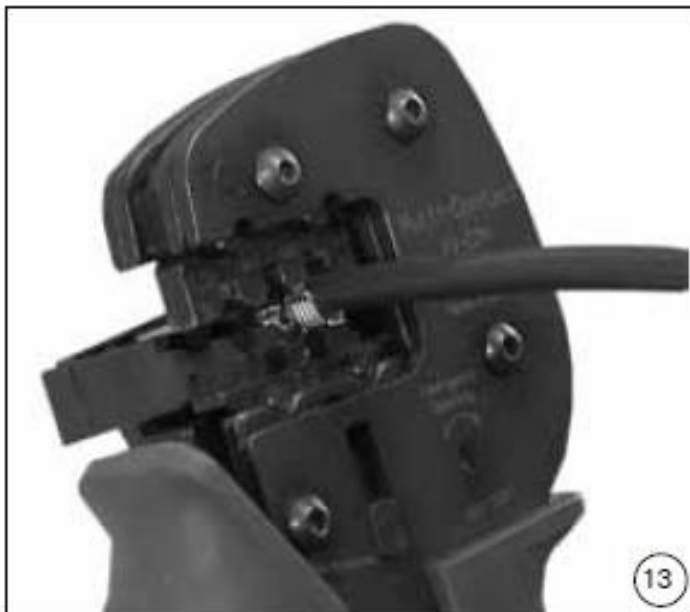

**(ill. 13)**

Insert the stripped cable end until the insulation comes up against the crimp insert. Completely close the crimping pliers.



**(ill. 14)**

Visually check the crimp.

**i Note:**

For directions on the operation of the crimping tool, please see operating instructions MA251 at [www.multi-contact.com](http://www.multi-contact.com)



## Assembly check

### (ill. 15)

Insert the crimped-on contact into the insulator of the male or female coupler until it clicks into place. Pull gently on the lead to check that the metal part is correctly engaged.



### (ill. 16)

Insert the appropriate end of the test pin into the male or female coupler as far as it will go. If the contact is correctly located, the white mark on the test pin must still be visible.



### (ill. 17)

Screw up the cable gland hand-tight with the tools **PV-MS**

or

tighten the cable gland with the tools **PV-WZ-AD/GWD** and **PV-SSE-AD4**.

### In both cases:

The tightening torque must be appropriate for the solar cables used. Typical values are between 2.5Nm and 3Nm.

## Plugging and unplugging the cable coupler without safety lock olip PV-SSH4

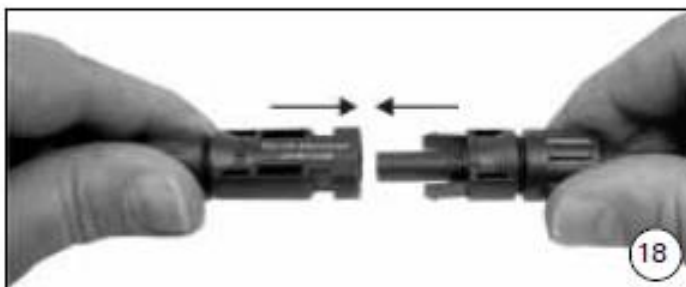

### Plugging

#### (ill. 18)

Plug the parts of the cable coupler together until they click in place. Check that they have engaged properly by pulling on the cable coupler.

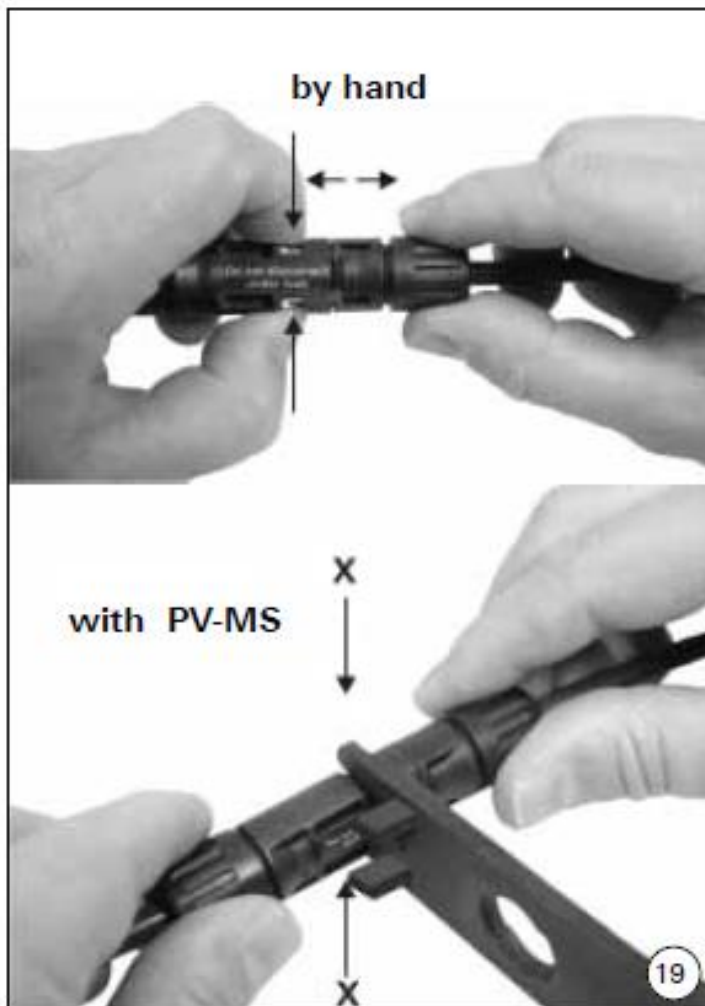

## Unplugging

(ill. 19)

To disconnect the contacts, press the latches (X) together either by hand or with the tool PV-MS and pull the halves of the cable coupler apart.



## Plugging and unplugging the cable coupler with safety lock olip V-SSH4

### Plugging

(ill. 20)

Plug the parts of the cable coupler together until they click in place. Check that they have engaged properly by pulling on the cable coupler.

### Unplugging

The cable coupler can be disconnected only with the tool PV-MS. Press the latches (X) together with the tool PV-MS and pull the halves of the coupler apart.

## 1. Product warranty

- 1.1. Heckert Solar GmbH (hereinafter referred to as Heckert Solar) warrants for the delivered standard modules that they are free from material and manufacturing faults (extended warranty). A natural detraction is not taken as a fault.
- 1.2. The product warranty is granted for 11 years, beginning with the delivery to the contractual partner of Heckert Solar.
- 1.3. Warranty covers (at the option of Heckert Solar) repair, replacement delivery of identical or similar modules as regards power class or refund of purchase price. The overall performance of the modules to be replaced is decisive. Warranty excludes costs for dismantling, transport and re-installation of modules as well as costs arising from loss of earnings due to yield reduction. Further claims, in particular compensation claims, are excluded, too. Replaced modules shall become the property of Heckert Solar.
- 1.4. As Heckert Solar uses only solar glass of a very high quality, damages can generally only be caused by mechanical impact. Therefore, Heckert Solar assumes no warranty for the solar glass. Furthermore, product warranty does not cover abrasion such as scratches, spots, rust and discolorations.

## 2. Performance warranty

- 2.1. Heckert Solar insures that the solar modules produce
  - at least 90% during a period of 10 years and
  - at least 80% during a period of 25 years

of the minimum performance registered in the respective data sheet (in consideration of the usual measuring tolerances). These periods are valid as from delivery to the contractual partner of Heckert Solar.

- 2.2. Warranty basis is the measurement of module performance by Heckert Solar with own measuring devices under standard measuring conditions (according to IEC EN 61215 and 60903-3).
- 2.3. Performance warranty shall always enter into force when the solar modules produce demonstrably less power than the above-mentioned percentage figures of the minimum power due to aging effects of cells, glass or embedding foil.
- 2.4. Warranty comprises, at the option of Heckert Solar, the delivery of additional or replacement of modules with new or repaired modules or partial refund of purchase price. Provided that the originally delivered module type is no longer produced in series, substitute modules or additional modules of the respective current standard types are delivered. Warranty excludes costs for dismantling, transport and re-installation of modules as well as costs arising from loss of earnings due to yield reduction. Further claims, in particular compensation claims, are excluded, too.

## 3. Product and performance warranty is excluded,

- if the defect of a solar module was caused by system components like cables, inverters, connectors etc.;
- if performance fault is caused by overvoltage, flash of lightning, inundation, fire or similar events;
- if the modules are damaged by abuse, negligence, accident, vermin, mechanical impacts or force majeure;
- if the modules are damaged, destroyed or affected by improper installation, utilization, usage operation, storage or transport, by soiling or usage under inappropriate environmental conditions;
- if the solar module was exposed to any kind of technical manipulations;
- if the modules were exposed to interventions of third persons;
- if serial numbers or type signs were exposed to manipulations or if the modules cannot be clearly identified for other reasons;
- if the modules are not operating in the plant where they have been installed for the first time or if they operate on mobile objects like vehicles or ships.
- Warranty period shall not be prolonged by additional or replacing deliveries.

## 4. Validity of warranty rights

- 4.1. Warranty conditions can only become valid upon presentation of copies of the serial number as well as respective invoice issued by Heckert Solar or the seller by submission of the completed form "Reklamation" (PDF-file to be downloaded at [www.heckert-solar.com/Downloads](http://www.heckert-solar.com/Downloads)). These documents shall be presented to Heckert Solar or to the contractual partner of Heckert Solar in order to assert the claim.
- 4.2. Obvious damages have to be shown immediately to Heckert Solar in writing, latest within 7 days after receipt of the goods; not-obvious damages at discovery. Returned damaged modules will not be accepted without prior demand in written issued by Heckert Solar.

Further claims apart from the above-mentioned are excluded, in particular those on damage claims, which have not originated on the modules delivered. This shall not apply unless in case of intention, culpable negligence, absence of warranted characteristics and the culpable violation of essential contractual obligations according to the law imperative liability is being provided. Heckert Solar is also not liable for consequential damages. This applies to additional, consequential or other, whatever caused damage.
- 4.3. The period of limitation of damage claims shall be 6 months, beginning with passing of the risk, yet no later than 6 months after the damage has occurred.

This warranty replaces any previously given English versions. This warranty is valid regardless of legal specifications in Europe and Switzerland. The services granted on the basis of this declaration are subject exclusively to German law. The place of performance is Chemnitz.

Valid from November 26<sup>th</sup> 2018.

Please note: This document has been translated into several languages. If variances occur between different language versions the German original version needs to be taken for validity.